

Meicheng®

MT-1 Digital Music Tutor

USER MANUAL



www.meicheng.com.tw

MT-1

Thank you for purchasing Digital Music Tutor. This classical and elegant machine equips with leading digital recording technology, for musician, language teachers and students. The digital recording technology bring pure and wide sound effect, suitable for piano, string, pipe and all kinds of instruments. The USB port may connect to PC for easy download and duplication. To own a Digital Music Tutor, to win your music practice more effective and enjoyable..

I. Introduction of the Digital Music Tutor.....	P2
II.Product Fixture.....	P3
III. Parts introduction	
A. Description of switch and jacks.....	P4
B. Description of key control.....	P5
C. Description of MODE key.....	P5
D. Switch and jacks on back panel.....	P6
IV. How to operate RECORD	
A. How to record.....	P6
B. Record from microphones.....	P7
C. Record from LINE IN source	P7
D. The suitable position to record.....	P7
V. How to operate PLAY function	
A. Enter VOC or MP3 mode.....	P8
B. How to operate PLAY.....	P8
C. Forward or Rewind.....	P8
D. Three repeat function.....	P9
E. Select EQ mode.....	P9
VI. How to delete files.....	P10
VII. Download files from computer.....	P10
VIII. Specifications.....	P12

I. Introduction of the Digital Music Tutor

Features of Digital Music Tutor :

A. Leading MP3 compression recording technology

What is the difference between digital recording and traditional recording? The Digital recording transfers sound into 0101 digital data, the data is easy to be stored, filed into the appliances cooperate with computers, such as softdisk, harddisk, flash memory, SD memory card.... And the data can be edited by computer to be MIDI music, email, or played on MP3 player. The Digital Music Tutor records the music directly into MP3 compression, 128K high sampling quality to produce very clear and wide sound effect.

B. Two data storage appliances on the machine

The Digital Music Tutor equips 128MB flash memory, can store about 120 minutes music data. Besides the installed memory, the machine provides an extension socket for SD memory card (up to 512MB) also. The compression type of the machine takes approx. 1MB for 1 minute recording data, it is easy for you to count out how long your SD memory card can record. Before you record and play, you must make sure the right memory you are using.

C. Record tracks selection

The Digital Music Tutor provides 99 tracks for your recording. Select the track number before you record, when the recording is finished, the data will be named with the track number, and will not change even the other tracks were deleted. You can select any track number you want to record, no limit to number sequence or recording time of each tracks.

D. MP3 and VOC modes

Besides digital recording function, the Digital Music Tutor also provides MP3 music playing function. When you download MP3 music from computer, the MP3 music files will store into MP3 mode automatically. On the other hand, when you record music from microphones or LINE IN source, the music files will store into VOC mode. The double modes function provides flexible usage for your learning and leisure time.

E. Leading and unique sound mixer technology

The Digital Music Tutor equips an build-in microphone, and two extension microphone jacks,

you can use one to three microphones to record, all the sound sources will mix up. Besides microphones, you can record the sound from CD player, tape recorder, radio...etc by connect the appliances to the LINE IN jack of the Digital Music Tutor, the sound from LINE IN can also mix up with microphone sources.

Our leading and unique sound mixer technology is suitable to multi instruments playing occasion, or mix background music from CD with your playing. Surely, you may create more functions on the Digital Music Tutor and enjoy it.

II. Product Fixture

MT-1

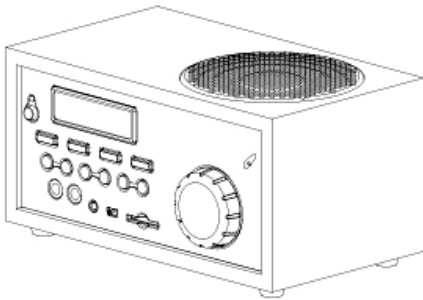

Adapter

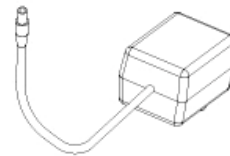

Lavalier MIC.

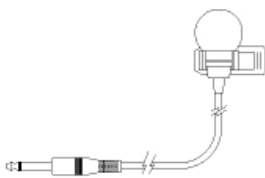

USB Cable



III. Parts Introductions

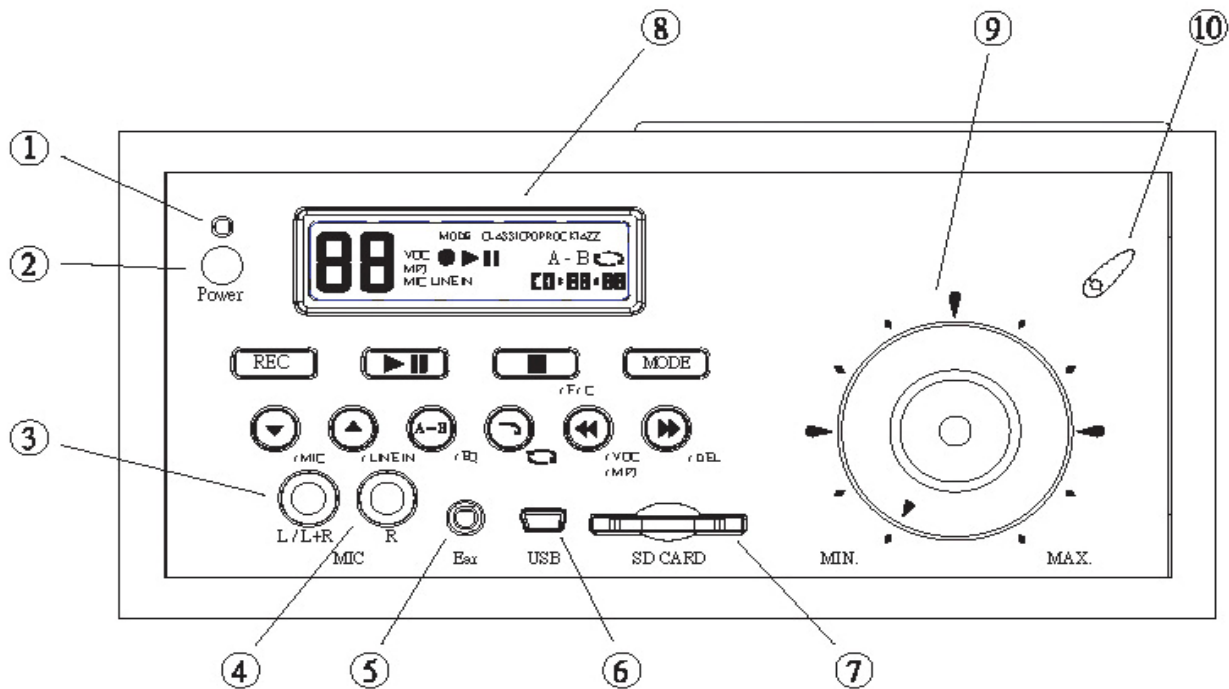

A. Description of switch and jack:

1. Power indicator:

The LED will turn RED when power on.

2. Power switch:

Plug DC power adaptor then turn on the switch to work.

3. Extension microphone jack (left channel/stereo channel):

Plug one microphone at the jack to have stereo effect, plug two microphones to have left channel effect.

4. Extension microphone jack (right channel):

Plug microphone to this jack to have right channel effect.

5. Earphone jack:

Plug earphone at the jack, then the speak will be off.

6. USB port:

Connect USB cable to computer to download or duplicate files.

7. Extension SD memory card socket:

Plug SD memory card (up to 512MB)

8. LCD monitor:











Showing the operating situation

9. Volume control knob for speaker

10. Build-in microphone:

A condenser microphone is installed.













B. Description of key control :

	Record key: push the key to record.
	Play/Pause key: Push the key to play; Push it during play will pause playing, push it again to resume.
	Stop key: Push the key to stop or cancel motions, ex: record, play, delete...
	Mode key: A mode key to provide more functions, will introduce the functions on next page.
	Track down select key: Press the key once to select the next number; Hold down the key to move track number quickly.
	Track up select key: Press the key once to select the previous number; Hold down the key to move track number quickly.
	A - B repeat key: Press the key during playing to indicate the repeat starting point (A point), then press the key again to indicate the repeat ending point (B point). Then the music will play from A to B points again and again until you press the key again to stop
	Repeat key: Press the key during playing, the track will repeat always. If you press the key twice, the machine will repeat all the tracks. Press the key again to cancel repeat.
	Rewind key: Hold down the key to rewind playing.
	Forward key: Hold down the key to forward playing.

C. Description of MODE Key:

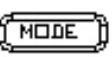
The MODE key is used to provide more functions. To operating MODE function, push MODE key at first, the LCD will show MODE, please press the other function key immediate to operate the MODE function.

Followings are the description of MODE functions:

 + 	Installed microphone selection function: it can turn on/off the install microphone to record.
 + 	LINE IN select function: it can turn on/off the LINE IN as record source.
 + 	EQ select function.
 + 	VOC or MP3 mode select function: before record/play,you must select to enter VOC or MP3 mode.
 + 	Delete files inside flash memory or SD memory card.
 + 	Flash memory or SD memory card selection function

D. Switch and jacks on back panel:

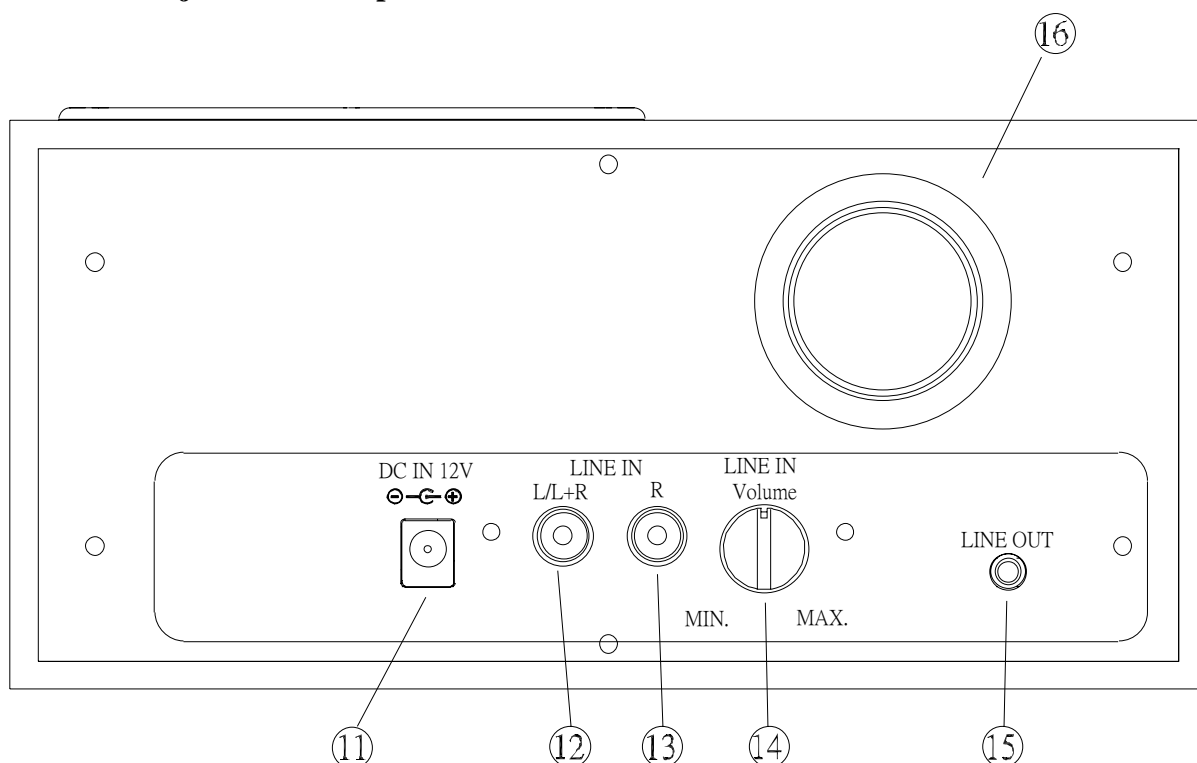

11. DC power adaptor jack: plug the adaptor into the jack before you turn on the power switch.
12. LINE IN jack (left channel/stereo channel): connect to CD player, tape recorder, radio...as record source. Plug one jack to be stereo channel, plug two jacks as left channel.
13. LINE IN jack (right channel): connect to CD player, tape recorder, radio...as record source. Plug this jack as right channel.
14. LINE IN volume control knob: control the volume level of LINE IN source
15. LINE OUT: connect to larger amplifier and speaker.
16. Sound box ventilation.

IV. How to operate RECORD function

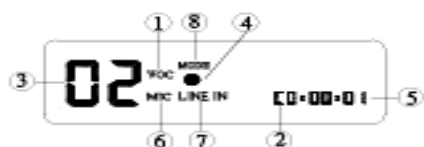





A. How to RECORD

1. The machine can only record in VOC mode. To change to VOC mode, press **MODE** + **⏪**, when LCD shows VOC (1), means you are in VOC mode.

2. Then you shall decide to record on flash memory or SD card. Press **MODE** + **■**

to interchange flash memory (F) and SD card (C) (2).

3. Press   to select record track, select from 01 to 99 tracks (3). Press  when track number has been selected (4). The clock start to run means record is processing (5).

Press  to finish record.

4. If the track you select to record has been occupied, the LCD will show  to remind you.

You

shall delete the occupied file before you update new recording. (Please see DELETE on page 11).

5. When the memory has less than 30 second memory capacity, the LCD will start to count down from 30, 29, 28... Please change new SD card or stop recording.

B. Record from microphones:



1. The machine equips an build-in microphone and two extension microphone jack, the three microphones sources will mix up. You can turn the build-in microphone off when press

 + , and the MIC will disappear. (see 6)

2. The sound of the installed microphone is for stereo channel. For expanded microphones, if plugs one microphone on left jack, it is stereo sound; If plug two microphones, the sounds will be separate into left and right channels.

C. Record from LINE IN source

1. The machine may record from LINE IN sources, such as CD player ,tape recorder, radio.... Connect signal cable from the LINE IN jack on the back panel to LINE IN appliances, the LCD

shows LINE IN (see 7) means LINE IN is on. Press  +  if the mark are not shown on LCD.

2. LINE IN volume level is adjustable.

3. The sound from LINE IN will mix up with the sound from microphones. Remember to turn off the build-in microphone if you do not want to record microphone source.

D. The suitable position to record:

1. To produce best recording result, we suggest you to put the machine at the distance of 30 – 60 cm from the instruments at table height.

2. As each instruments produce different sound level, the position to put the machine shall adjust according to the sound level of the instruments you are recording.

3. In multi instruments playing occasion, the machine shall be put near the instrument with

smaller sound level, or use expanded microphone for the instruments.

4. If you want to record teachers' speech together with the playing of instruments, teachers can use tie-clip microphone for better sound effect.
5. For better recording effect, the tie-clip microphone can be clip on the score stands or the body of a player.

V. How to operate PLAY function

A. Enter VOC or MP3 mode?

Enter VOC mode to play the files recorded from microphones and LINE IN; Enter MP3 mode to play the files downloaded from computer. The method to interchange VOC or MP3 modes :

Press  + , take reference to the below LCD indication.

Play in VOC mode



Play in MP3 mode



B. How to operate PLAY function?

Setup flash memory or SD card (take reference to the operation on P. 9) , then select the track

number you want to play and press  . The LCD will show  and start to



play. Press  during playing to pause, the LCD show  and flash. Press the key again to continue playing.

Playing

Pause



C. Forward or rewind during playing



Hold down  during playing to rewind playing, hold down  to forward playing, the clock will move quickly according to the time of recording. Release the key and back to normal play.

D. Three REPEAT functions:

A - B Repeat: Press  during playing to indicate the repeat start point (A point), then press the key again to indicate the repeat finish point (B point). Then the music will play from A to B points again and again until you press the key again to release. The A-B repeat function is benefit to learn a difficult phase.

A-B repeating



Repeat and Repeat ALL: press  during playing, the track will repeat always. If you press  twice, the LCD shows  and will repeat all the tracks. Press the key again until the repeat mark disappear on LCD to release repeat function.

* Repeat ALL function does not work in VOC mode.

Repeat

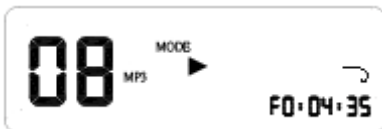



Repeat ALL



E. Select EQ mode

The machine provides 5 different EQ modes during MP3 playing, they are: NORMAL, CLASSICAL, POP, ROCK, JAZZ

Press  and  to select EQ modes on LCD (press once to jump to next mode, but

NORMAL will not show up on LCD). Press  again when you finish EQ selection.

Select EQ mode



VI. How to delete files

You can delete the stored files by computer, or by the machine itself. Following is the way to delete by the machine itself.

Select the track no. to delete, press  +  , the LCD will show "d EL". You need to press



again, then the machine start to delete the track. When the "d EL" is disappear and the clock return to 0:00:00, means the track is empty and are able to record new data again.



Delete data

VII. Download files from computer

The machine may connect to computer and download music to play.

First, if the operation system of your computer is below WINDOWS 98 (include WINDOWS 98), you need to install USB driver into your computer before download. The computer will take the Digital Music Tutor as a removable disk when they connect successfully, then you can start to download music from the computer, or duplicate the recording files from the Digital Music Tutor to computer. As the recording files from the Digital Music Tutor has been compressed to MP3 format, it is easy to play the file without any transference. The music you has downloaded stores into MP3 mode automatically. If you want to store the music to VOC mode, the file name of the music shall be changed to following format, otherwise the machine can not recognize them.

- a. If you want to download music to VOC mode, and store into the flash memory, the file name shall be change to: M_INT_xx.mp3 (xx means the track no. you want to store to, ex. 03 is track no. 3)
- b. If you want to download music to VOC mode, and store into the SD card, the file name shall be change to: M_EXT_xx.mp3 (xx means the track no. you want to store to, ex. 03 is track no. 3)

The original file name

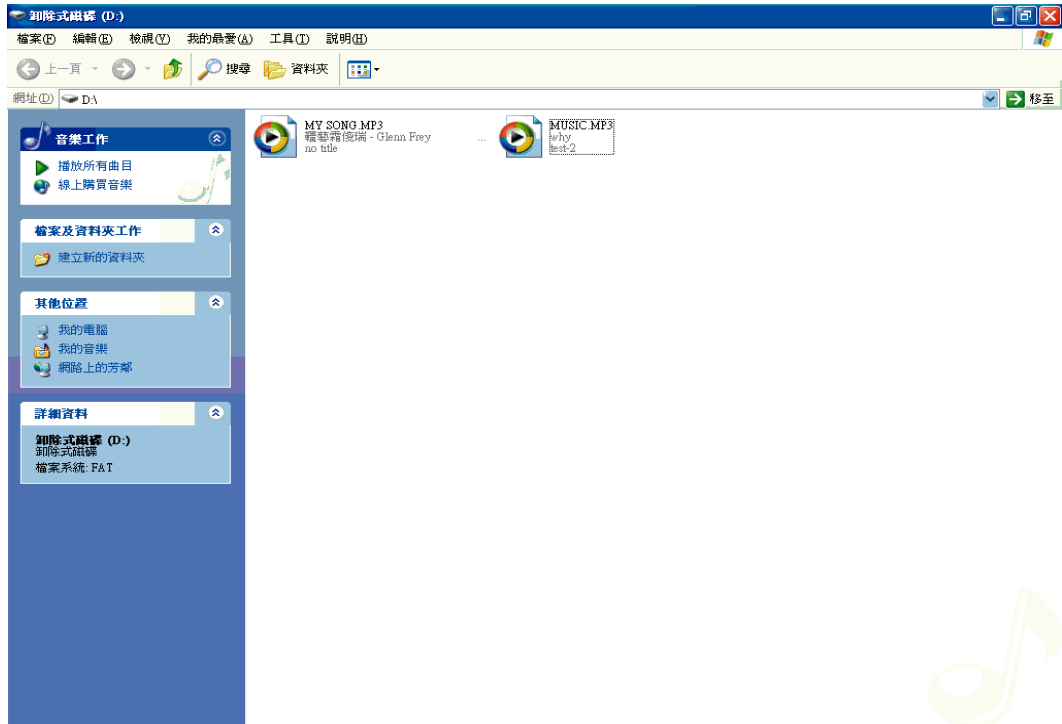

The revised file name

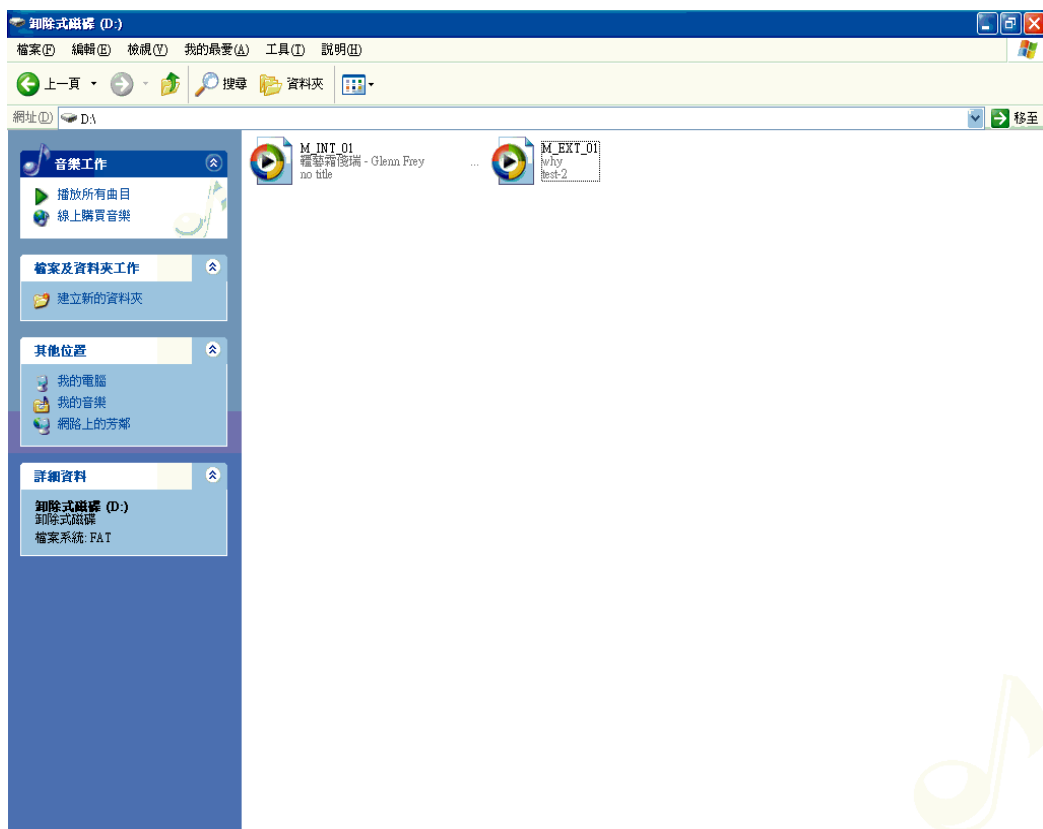

VIII.Specifications

Memory capacity:	128MB
Store limit:	Over 10 years
Writing times:	Over 100,000 times
MIC. type:	unidirectional electric condenser MIC.
Frequency response :	100Hz - 12KHz (MIC.) 50 Hz - 15KHz (LINE IN)
Impedance:	600 Ohm
Balance output:	-60dB (at 1 KHz)
USB Type:	USB 1.1
Power requirement:	DC 12V 420mA
Current consumption:	Stand by < 120mA MAX.<15A(at 0dB,1KHz)
Computer operation system:	Windows 98 、 2000、 XP

Meicheng[®] MEI CHENG AUDIO VIDEO CO., LTD
Address: 5F., NO.111, SEC. 2, HUAN HO N. RD., TAIPEI, 10376 TAIWAN
Tel: +886(2) 2585 3869, Fax: +886(2) 2593 6672
Website: www.meicheng.com.tw Email: mei.cheng@msa.hinet.net